

Réf. **92.046**

Réf. **92.048**

 Réf. **47.578**

 Réf. **49.578**

**Kit d'encastrement 1/2" + Habillage pour robinet à encastrer**

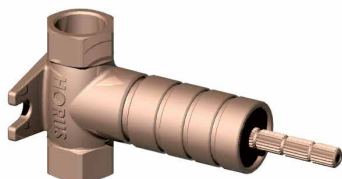

**CARACTÉRISTIQUES Réf. 92.046**

Kit d'encastrement 1/2" tête ouverture droite  
Kit for concealed installation 1/2" right turn opening

**CARACTÉRISTIQUES Réf. 92.048**

Kit d'encastrement 1/2" tête ouverture gauche  
Kit for concealed installation 1/2" left turn opening

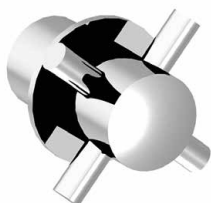

**CARACTÉRISTIQUES Réf. 47.578 / Réf. 49.578**

Habillage pour robinet à encastrer et pour inverseur  
Trim for wall valve + diverter

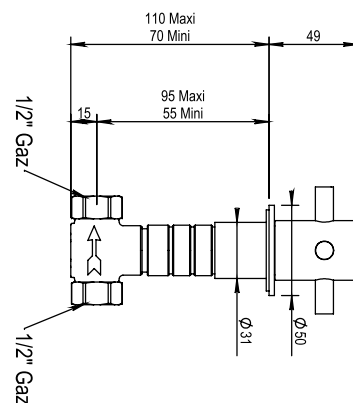





16 ACC LY 712

**FINITIONS USUELLES**

-  **CH** Chrome  
Chrome
-  **NM** Nickel Mat  
Brushed Nickel

**FINITIONS SPÉCIALES**

**FINITIONS DÉCORATIONS**

-  **CT** Cuivre Satiné  
Copper Satin
-  **LS** Laiton Satiné  
Soft Brass
-  **CF** Canon de Fusil  
Metal Gun
-  **NS** Nickel Satiné  
Nickel Satin
-  **NO** Noir Mat  
Black

**FINITIONS PVD**

-  **CP** Champagne  
Champagne
-  **CR** Pink  
Pink
-  **NN** Glossy Black  
Glossy Black

