

Réf. **81.523**

Réf. **81.593**

Box mitigeur thermostatique encastré 3 voies + habillage pour box mitigeur thermostatique



MONTAGE HORIZONTAL ET VERTICAL
HORIZONTAL OR VERTICAL ASSEMBLY

CARACTÉRISTIQUES Réf. 81.523

Habillage pour box mitigeur thermostatique.
Trim for thermostatic mixer.

CARACTÉRISTIQUES Réf. 81.593

Box mitigeur thermostatique encastré 3 voies.
Insert box for thermostatic mixer with 3 outlets.

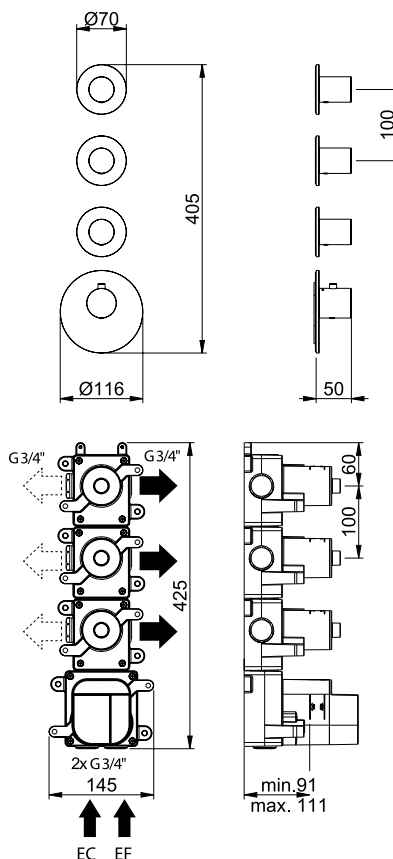

16 ACC LY 190

FINITION USUELLE



FINITIONS PVD

